

APDI-29-1.5G-W

OVERVIEW

APDI-29-1.5G-W is the InGaAs avalanche photodiode coupled to an optical fiber and packaged into a hermetic case

MAIN FEATURES

- Bandwidth: 1.5 GHz
- Spectral range: 1000 - 1650 nm
- Package types: coaxial with or without bracket
- Low dark current typ. <1 nA

APPLICATIONS

- Optical fiber communication systems
- OTDR

ORDERING INFORMATION

APDI-29-1.5G-W - X-X-5-X-X-X

Back reflection

R10: back reflection -10 dB

Case type

U: compact coaxial

B: compact coaxial with double-sided bracket

Other type: on request

Fiber type

SMT: SM, [Corning Titania-Clad](#), furcation tubing Ø0.9 mm, ultrasmall bending radius 2.5 mm

SM1: SM, G.657.A1, [Corning SMF-28 Ultra](#), furcation tubing Ø0.9 mm or **BSM1** Ø0.25mm

SM3: SM, G.657.B3, [Corning ClearCurve ZBL](#), furcation tubing Ø0.9 mm or **BSM3** Ø0.25mm

MM5: MM, [50/125.OM2](#), furcation tubing Ø0.9 mm

Other type: on request

Connector type

FA: FC/APC (SM1, SM3, SMT)

FU: FC/UPC (SM1, SM3, SMT, MM5, MM6)

SA: SC/APC (SM1)

SU: SC/UPC (SM1)

N: no connector

Other type: on request

Fiber length

0.5: 500+/-50 mm

1.0: 1000+/-100 mm

Other length: on request

APDI-29-1.5G-W

ABSOLUTE MAXIMUM RATINGS

Parameter		Value	Unit	Conditions
Reverse current	I_R	2	mA	
Forward current	I_F	10	mA	
Operating temperature	T_{op}	-40 ÷ +85	°C	Package U, B
Storage temperature	T_{stg}	-40 ÷ +85	°C	
Soldering temperature	T_{sold}	260	°C	Max. 5 seconds

ELECTRICAL-OPTICAL CHARACTERISTICS (T = 25 °C)

Parameter		Min	Typ	Max	Unit	Conditions
Operating wavelength		1000		1650	nm	
Responsivity @0.95V _{BR}	R	10	12		A/W	$\lambda = 1310$ nm, SM1, SM3, MM5 $V_R = 0.95V_{BR}$
Dynamic gain*	dM	5.5	7	9		$\lambda = 1310$ nm
Return loss	RL		10		dB	SM1, SM3, MM5
Breakdown voltage	V _{BR}	40	55	70		$I_d = 100$ μ A
Breakdown voltage temperature coefficient $\Delta V_{BR} / \Delta T$	δ		0.09		V/°C	T = 25 °C
Dark current	I_d		0.3	3	nA	$V_R = 0.9 V_{BR}$
Total capacitance	C _t		0.4	0.6	pF	f = 1 MHz
Bandwidth	BW	1.5			GHz	M = 10

*Dynamic gain $dM = 5 \times \lg(M2/M1)$, where M1 is gain at V = 30 V, M2 is gain at voltage where noise increases by 15 %

APDI-29-1.5G-W

CHARACTERISTICS (T = 25 °C)

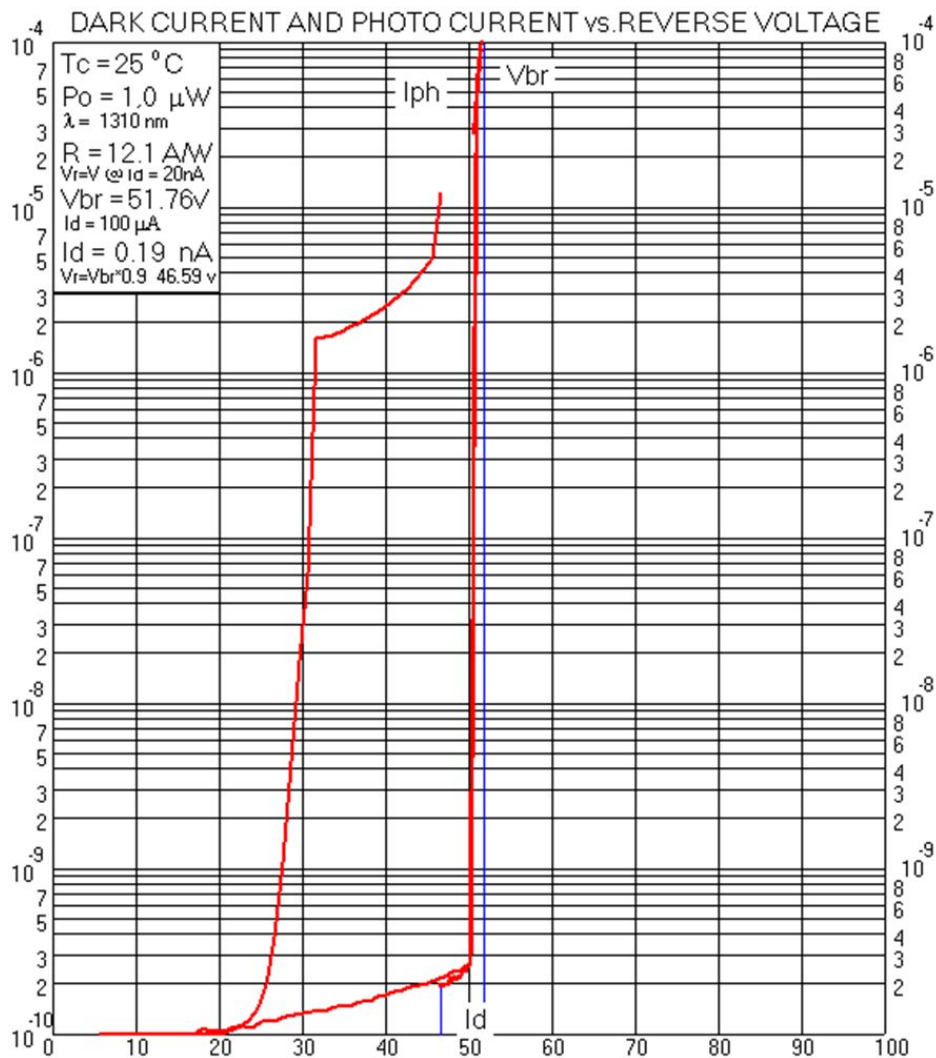

APDI-29-1.5G-W

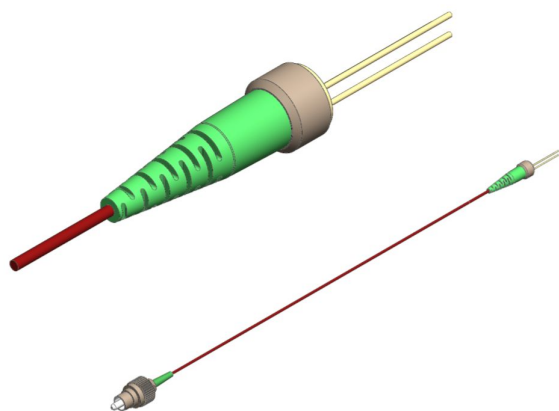

PACKAGE U

BACK VIEW

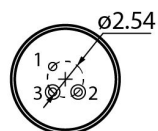

PINOUT
#5

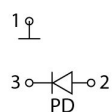

Download more information

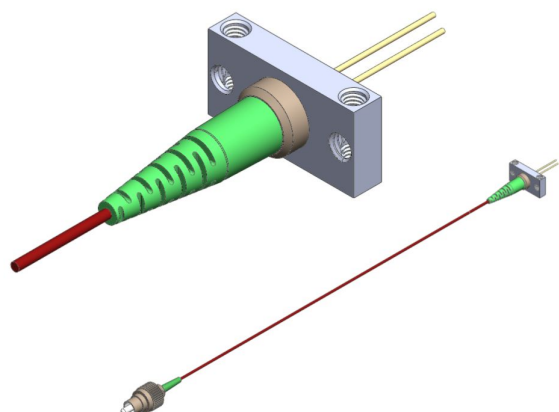

PACKAGE B

BACK VIEW

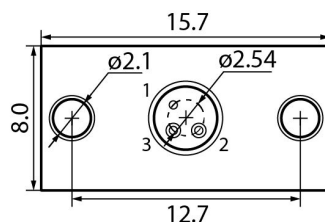

PINOUT
#5

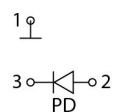

Download more information



APDI-29-1.5G-W

Characteristics, data, materials and structures specified in this datasheet are subject to change without notice. Please refer to the latest specification before use of the products.

Safety and handling cautions

1. Avoid smashing and burning of the module. Avoid storing and using the module in conditions where water, organic solvents or aggressive acids or bases may contact the module or where there is a possibility of exposure to corrosive gases, explosive gases, dust, salinity or other harsh conditions. The module should be disposed as special industrial waste.
2. Exceeding absolute maximal ratings even for a short time can cause permanent damage of the module.
3. The module is sensitive to and can be broken by ESD (static electricity).

Conflict Minerals Policy Statement

LasersCom LLC achieves business objectives and customer needs with social responsibility. We do not support or contribute to the violence and human rights violations associated with the mining of conflict minerals coming from Conflict Regions according to US "Dodd-Frank Act". When possible, our suppliers' conflict mineral statements are reviewed. We do not directly purchase Conflict Minerals from any source and do not knowingly procure any parts and products containing Conflict Minerals from Conflict Regions.

RoHS Compliance Statement

Restriction of Hazardous Substances (RoHS) directive (Directive 2011/65/EC amended with Directive (EU) 2015/863) is the directive aimed at reducing the harmful environmental impact of waste electrical equipment by restricting the use of known dangerous substances. Based on information received from our supply sources, LasersCom LLC hereby states that the banned substances listed in the RoHS directive are not found in the parts and materials used above the threshold level listed other than exceptions approved by the European Commission.

REACH Compliance Statement

Registration, Evaluation, Authorisation and Restriction of Chemicals (REACH) is a European Union regulation 1907/2006/EC that addresses the production and use of chemical substances, and their potential impacts on human health and the environment. Based on information received from our supply sources, LasersCom LLC hereby states compliance of the parts and materials used in manufacturing to REACH regulation. LasersCom LLC does not manufacture or import any substances or preparations as defined under REACH.