

LDS-1330-DFB-10G-10/30

OVERVIEW

LDS-1330-DFB-10G-10/30 is the MQW laser diode coupled to an optical fiber and packaged into a hermetic case. The special feature of the LDS technology is the increased thermal stability of optical power

MAIN FEATURES

- Wavelength: 1330 nm
- Cavity type: DFB
- Linewidth: 1 MHz
- Data rate up to 10 Gbps
- Optical power: up to 10 mW in CW mode, up to 30 mW in pulse mode in SM fiber G.657.A1
- Package types: coaxial, coaxial with bracket
- Built-in monitor photodiode

APPLICATIONS

- Optical fiber communication systems with data rate up to 10 Gbps
- Laser systems

ORDERING INFORMATION

LDS-1330-DFB-10G-10/30-X-12-X-X-X-X

Case type

U: compact coaxial (pulse mode only)
B: compact coaxial with double-sided bracket
 Other type on request

Fiber type

SM1: SM, G.657.A1, furcation tubing Ø0.9 mm
SM3: SM, G.657.B3, furcation tubing Ø0.9 mm
SMP13: PM, Fujikura SM13, PANDA type, furcation tubing Ø0.9 mm
 Other type on request

Connector type

FU: FC/UPC
FA: FC/APC
N: no connector
 Other type: on request

Test measurements

CW: CW mode (electro-optical parameters at T=25+/-5 C and spectrum)
P: pulse mode
CWP: both CW and pulse modes

Fiber length

0.5: 500+/-50 mm
1.0: 1000+/-100 mm
 Other length on request

LDS-1330-DFB-10G-10/30

ABSOLUTE MAXIMUM RATINGS

Parameter		Value	Unit	Conditions
Laser diode forward current	I_{FL}	120	mA	CW
		250	mA	Pulse
Laser diode reverse voltage	V_{RL}	2	V	
Photodiode reverse voltage	V_{RP}	20	V	
Photodiode forward current	I_{FP}	2	mA	
Operating temperature	T_{OP}	-40 - +85	°C	Package U, B
Operating temperature	T_{OP}	-40 - +50	°C	Package T, E
Storage temperature	T_{stg}	-50 - +85	°C	
Soldering temperature	T_{sold}	260	°C	Max. 10 seconds

ELECTRICAL-OPTICAL CHARACTERISTICS (T = 25 °C)

Parameter		MIN	TYP	MAX	Unit	Conditions
Wavelength	λ	1325	1330	1335	nm	CW, P = 10 mW
Spectral width	$\Delta\lambda$		0.11		nm	CW, P = 10 mW, -20 dB, OSA
Spectral width	Δf		1		MHz	CW, P = 10 mW, delayed self-heterodyne method
Side-mode suppression ratio	SMSR	40	55		dB	CW, P = 10 mW
Threshold current	I_{th}		5	10	mA	CW
Operating current	I_{op}		100	120	mA	CW, P = 10 mW, SM1
Slope efficiency	S_e	0.10	0.11		W/A	CW, SM1
Operating voltage	V_{op}		1.7	2.0	V	CW, P = 10 mW
Tracking error	E_r		0.15	0.30	dB	CW, P = 3 mW; T = -40 ÷ +80 °C
Pulse optical power	P_p	25	30		mW	Pulse, $I_{op} = 250$ mA
Resonance frequency	f_r		12.0		GHz	
Monitoring output current (PD)	I_m	0.5	0.7	5.00	mA	CW, P = 10 mW, $V_{rd} = 5$ V
Capacitance (PD)	C_t		10	20	pF	$V_{rd} = 1$ V, f = 1 MHz
Dark current (PD)	I_d			200	nA	$V_{rd} = 1$ V
Polarization extinction ratio	PER	20			dB	CW, SMP13

Pulse mode: pulse duration 10 μ s; duty cycle = 1%

Tracking error $E_r = \max [10 \lg [P(T)/P(25^\circ\text{C})]]$, $I_m = \text{const}$, $T = T_{\min} \div T_{\max}$

LDS-1330-DFB-10G-10/30

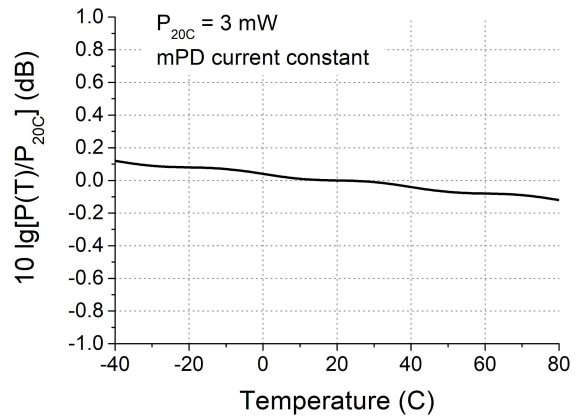
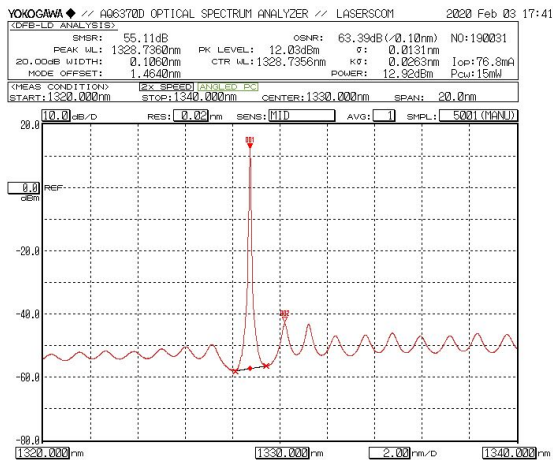
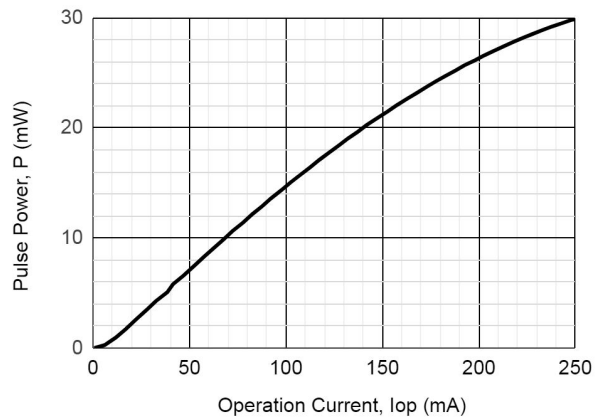
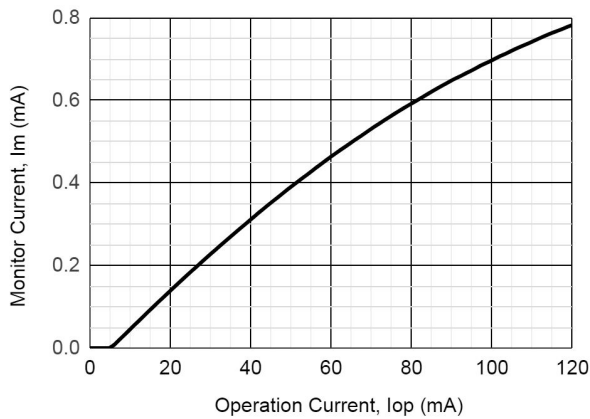
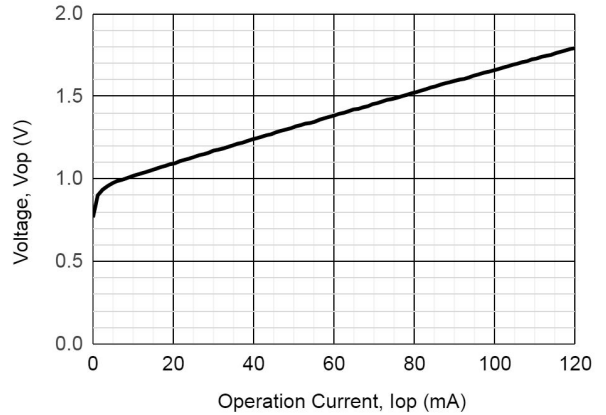
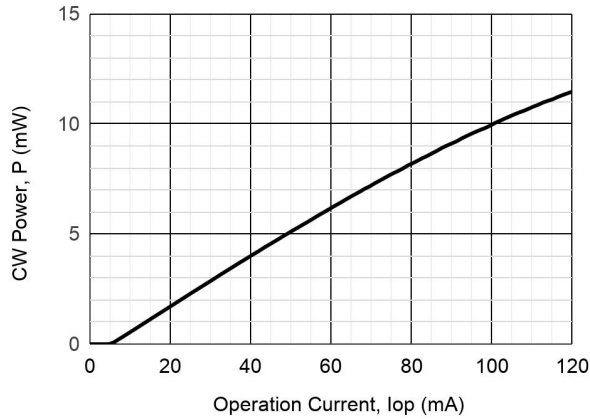

LDS-1330-DFB-10G-10/30

PACKAGE U

SIDE VIEW

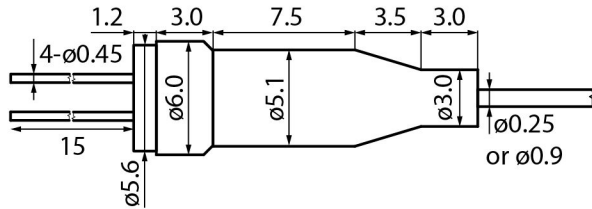

BACK VIEW

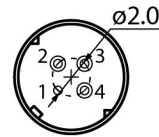

PINOUT #12

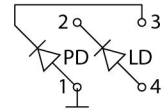

Connector FC/UPC, FC/APC, no connector, or by request

Fiber length 500+/-50, 1000+/-100, or by request

PACKAGE B

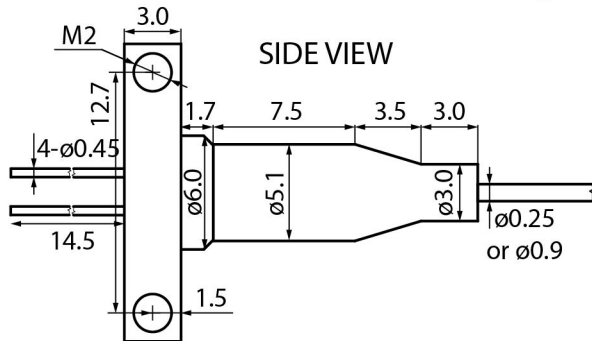

BACK VIEW

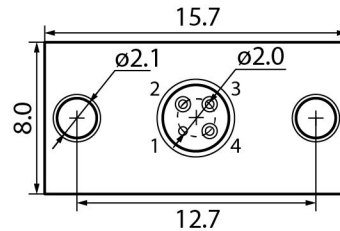

PINOUT #12

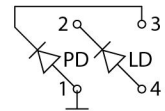

Connector FC/UPC, FC/APC, no connector, or by request

Fiber length 500+/-50, 1000+/-100, or by request

LDS-1330-DFB-10G-10/30

Characteristics, data, materials and structures specified in this datasheet are subject to change without notice. Please refer to the latest specification before use of the products.

Safety and handling cautions

1. Avoid smashing and burning of the module. Avoid storing and using the module in conditions where water, organic solvents or aggressive acids or bases may contact the module or where there is a possibility of exposure to corrosive gases, explosive gases, dust, salinity or other harsh conditions. The module should be disposed as special industrial waste.
2. Exceeding absolute maximum ratings even for a short time can cause permanent damage of the module.
3. The module is sensitive to and can be broken by ESD (static electricity).

Conflict Minerals Policy Statement

LasersCom LLC achieves business objectives and customer needs with social responsibility. We do not support or contribute to the violence and human rights violations associated with the mining of conflict minerals coming from Conflict Regions according to US "Dodd-Frank Act". When possible, our suppliers' conflict mineral statements are reviewed. We do not directly purchase Conflict Minerals from any source and do not knowingly procure any parts and products containing Conflict Minerals from Conflict Regions.

RoHS Compliance Statement

Restriction of Hazardous Substances (RoHS) directive (Directive 2011/65/EC amended with Directive (EU) 2015/863) is the directive aimed at reducing the harmful environmental impact of waste electrical equipment by restricting the use of known dangerous substances. Based on information received from our supply sources, LasersCom LLC hereby states that the banned substances listed in the RoHS directive are not found in the parts and materials used above the threshold level listed other than exceptions approved by the European Commission.

REACH Compliance Statement

Registration, Evaluation, Authorisation and Restriction of Chemicals (REACH) is a European Union regulation 1907/2006/EC that addresses the production and use of chemical substances, and their potential impacts on human health and the environment. Based on information received from our supply sources, LasersCom LLC hereby states compliance of the parts and materials used in manufacturing to REACH regulation. LasersCom LLC does not manufacture or import any substances or preparations as defined under REACH.