

# LDS-1550-FP-1.25G-10/20L

Preliminary

## OVERVIEW

LDS-1550-FP-1.25G-10/20L is the MQW laser diode coupled to an optical fiber and packaged into a hermetic case. The special feature of the LDS technology is the increased thermal stability of optical power

## MAIN FEATURES

- Wavelength: 1550 nm in CW mode
- Cavity type: Fabry-Perot
- Optical power: up to 10 mW in CW mode, up to 20 in pulse mode in SM fiber G.657.A1
- Package types: coaxial, coaxial with bracket, 14 pins DIL
- Built-in monitor photodiode

## APPLICATIONS

- Laser systems

## ORDERING INFORMATION

### LDS-1550-FP-1.25G-10/20L-X-2-X-X-X-X

#### Case type

U: compact coaxial (pulse mode only)  
 B: compact coaxial with double-sided bracket  
 T: 14 pins DIL with thermal stabilization (TEC and thermistor)  
 E: 14 pins DIL with thermal stabilization (TEC and thermistor)  
 Other type on request

#### Fiber type

SM1: SM, G.657.A1, [Corning SMF-28 Ultra](#), furcation tubing Ø0.9 mm  
 SM3: SM, G.657.B3, [Corning ClearCurve ZBL](#), furcation tubing Ø0.9 mm  
 SMP13: PM, [Fujikura SM13](#), PANDA type, furcation tubing Ø0.9 mm  
 MM5: MM, [50/125.OM2](#), furcation tubing Ø0.9 mm  
 MM6: MM, [62.5/125.OM1](#), furcation tubing Ø0.9 mm  
 Other type on request

#### Connector type

FA: FC/APC (SM1, SM3, SMP13)      FU: FC/UPC (SM1, SM3, MM5, MM6)  
 SA: SC/APC (SM1)                      SU: SC/UPC (SM1)  
 N: no connector  
 Other type: on request

#### Test measurements

CW: CW mode (electro-optical parameters at T=25+/-5 C and spectrum)  
 P: pulse mode (10 µs; duty cycle = 1%)  
 CWP: both CW and pulse modes

#### Fiber length

0.5: 500+/-50 mm  
 1.0: 1000+/-100 mm  
 Other length on request

# LDS-1550-FP-1.25G-10/20L

## ABSOLUTE MAXIMUM RATINGS

Parameter		Value	Unit	Conditions
Laser diode forward current	$I_{FL}$	105	mA	CW
		250	mA	Pulse
Laser diode reverse voltage	$V_{RL}$	2	V	
Photodiode reverse voltage	$V_{RP}$	20	V	
Photodiode forward current	$I_{FP}$	5	mA	
Operating temperature	$T_{OP}$	-40 - +85	°C	Package U, B
Operating temperature	$T_{OP}$	-40 - +50	°C	Package T, E
Storage temperature	$T_{stg}$	-50 - +85	°C	
Soldering temperature	$T_{sold}$	260	°C	Max. 10 seconds

## ELECTRICAL-OPTICAL CHARACTERISTICS (T = 25 °C)

Parameter		MIN	TYP	MAX	Unit	Conditions
Optical power (CW)	$P_{cw}$	10	12		mW	CW, $I_{op} = 100$ mA, SM1
Wavelength	$\lambda$	1520	1550	1580	nm	CW, $I_{op} = 100$ mA
Spectral width	$\Delta\lambda$				nm	CW, $I_{op} = 100$ mA, FWHM
Wavelength-temperature coeff.	$d\lambda/dT$		0.51		nm/°C	CW, $I_{op} = 100$ mA
Threshold current	$I_{th}$		10	15	mA	CW
Slope efficiency	$S_e$	0.10	0.13		W/A	CW, SM1
Operating voltage	$V_{op}$		1.8	2.0	V	CW, $I_{op} = 100$ mA
Tracking error	$E_r$		0.5	1	dB	CW, $I_{op} = 25$ mA, $I_m = \text{const}$
Pulse optical power	$P_p$	15	20		mW	Pulse, $I_{op} = 250$ mA
Rise and fall times	$t_r, t_f$			200	ps	20%-80%, package U, B
Monitoring output current (PD)	$I_m$	0.2	2.0	5.0	mA	CW, $I_{op} = 100$ mA, $V_{rd} = 5$ V
Capacitance (PD)	$C_t$		6	10	pF	$V_{rd} = 5$ V, $f = 1$ MHz
Dark current (PD)	$I_d$			100	nA	$V_{rd} = 5$ V
Polarization extinction ratio	PER	20			dB	SMP13

Pulse mode: pulse duration 10  $\mu$ s; duty cycle = 1%

Tracking error  $E_r = \max [10 \lg [P(T)/P(25^\circ\text{C})]]$ ,  $I_m = \text{const}$ ,  $T = T_{\min} \div T_{\max}$

# LDS-1550-FP-1.25G-10/20L

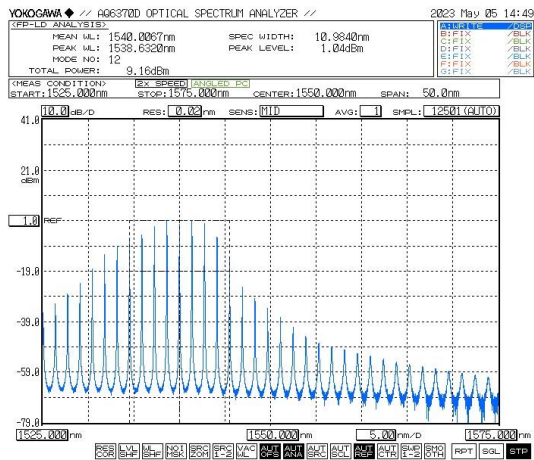
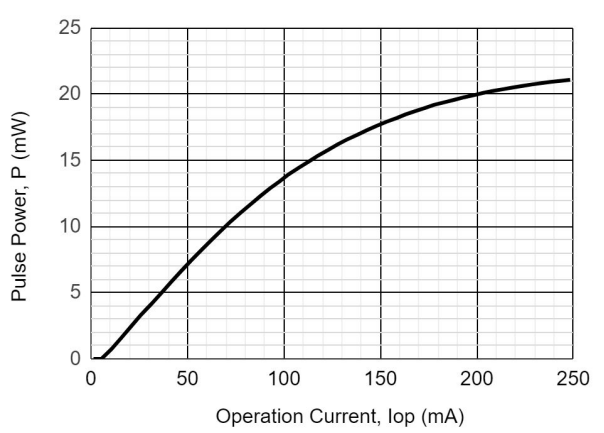
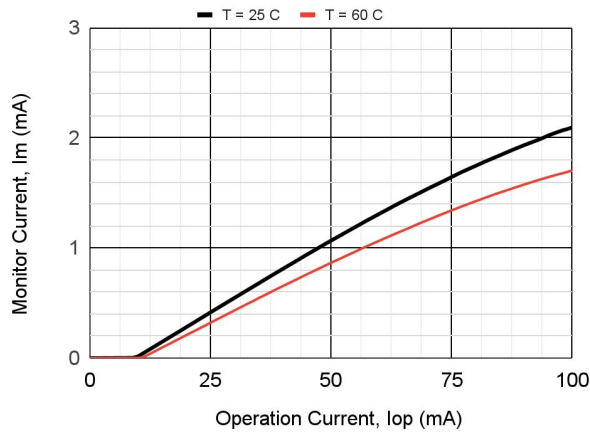
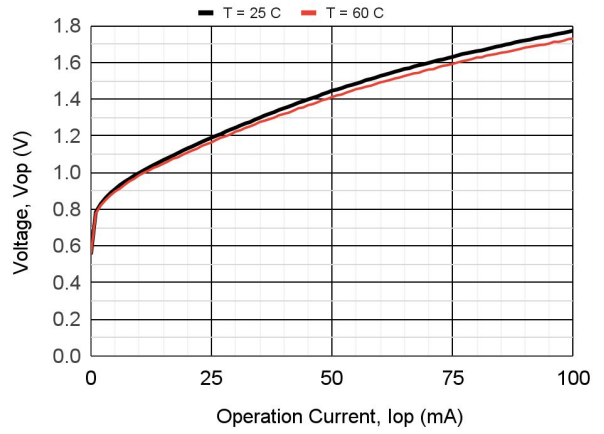
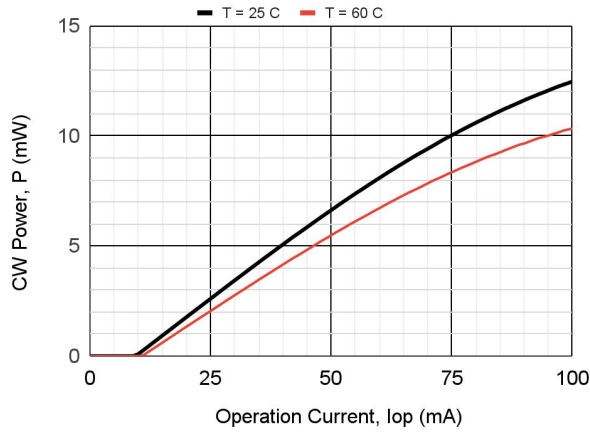

# LDS-1550-FP-1.25G-10/20L

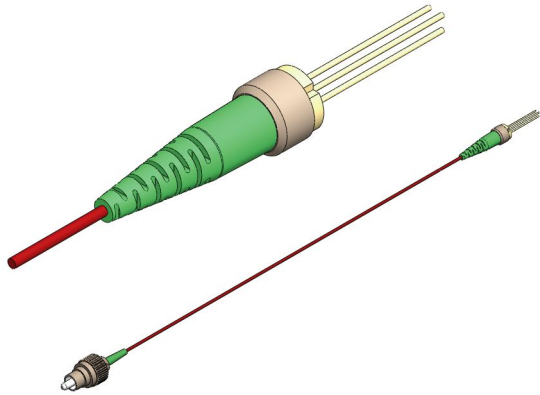

## PACKAGE U

BACK VIEW

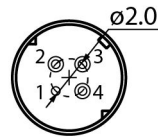

PINOUT  
#2

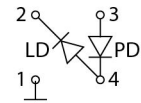

Download more information

Drawing

3D model

Application Notes

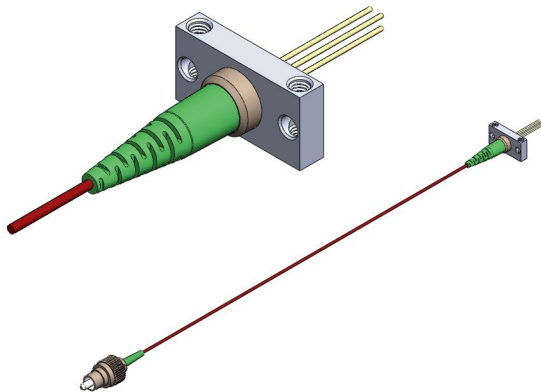

## PACKAGE B

BACK VIEW

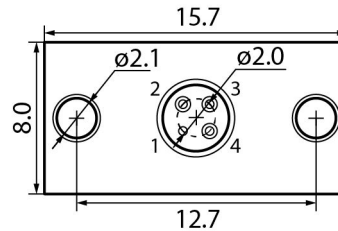

PINOUT  
#2

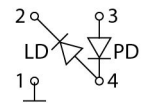

Download more information

Drawing

3D model

Application Notes

# LDS-1550-FP-1.25G-10/20L

## PACKAGE T

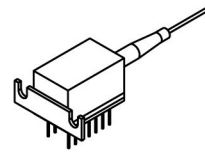
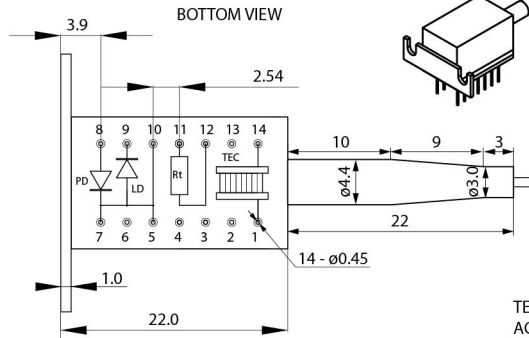
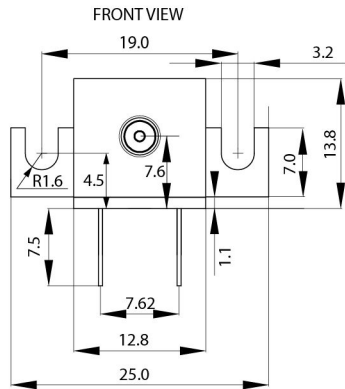

PINOUT #2, #3

- 1.TEC Anode
- 2.-
- 3.-
- 4.-
- 5.LD Anode
- 6.-
- 7.PD Cathode, LD Anode
- 8.PD Anode
- 9.LD Cathode
- 10.LD Anode
- 11.Thermistor
- 12.Thermistor
- 13.-
- 14.TEC Cathode

TEC:  $I_{max} = 0.7A$ ,  $U_{max} = 3.9V$ ,  $Q_{max} = 1.4W$ ,  
AC R = 4.7 Ohm,  $\Delta T_{max} = 72 K$

Thermistor:  
 $R_t = 10 * EXP(3600 * (1/T[K] - 1/298))$  kOhm

Download more information



Drawing



3D model



Application Notes

## PACKAGE E

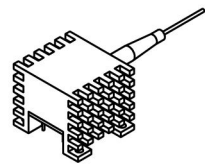
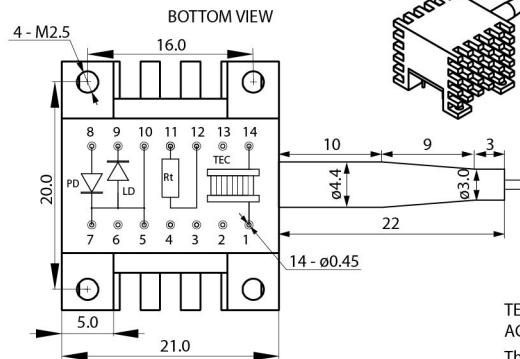
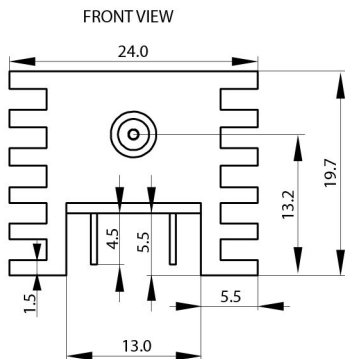

PINOUT #2, #3

- 1.TEC Anode
- 2.-
- 3.-
- 4.-
- 5.LD Anode
- 6.-
- 7.PD Cathode, LD Anode
- 8.PD Anode
- 9.LD Cathode
- 10.LD Anode
- 11.Thermistor
- 12.Thermistor
- 13.-
- 14.TEC Cathode

TEC:  $I_{max} = 0.7A$ ,  $U_{max} = 3.9V$ ,  $Q_{max} = 1.4W$ ,  
AC R = 4.7 Ohm,  $\Delta T_{max} = 72 K$

Thermistor:  
 $R_t = 10 * EXP(3600 * (1/T[K] - 1/298))$  kOhm

Download more information



Drawing



3D model



Application Notes

# LDS-1550-FP-1.25G-10/20L

---

Characteristics, data, materials and structures specified in this datasheet are subject to change without notice. Please refer to the latest specification before use of the products.

## **Safety and handling cautions**

1. Avoid smashing and burning of the module. Avoid storing and using the module in conditions where water, organic solvents or aggressive acids or bases may contact the module or where there is a possibility of exposure to corrosive gases, explosive gases, dust, salinity or other harsh conditions. The module should be disposed as special industrial waste.
2. Exceeding absolute maximum ratings even for a short time can cause permanent damage of the module.
3. The module is sensitive to and can be broken by ESD (static electricity).

## **Conflict Minerals Policy Statement**

LasersCom LLC achieves business objectives and customer needs with social responsibility. We do not support or contribute to the violence and human rights violations associated with the mining of conflict minerals coming from Conflict Regions according to US "Dodd-Frank Act". When possible, our suppliers' conflict mineral statements are reviewed. We do not directly purchase Conflict Minerals from any source and do not knowingly procure any parts and products containing Conflict Minerals from Conflict Regions.

## **RoHS Compliance Statement**

Restriction of Hazardous Substances (RoHS) directive (Directive 2011/65/EC amended with Directive (EU) 2015/863) is the directive aimed at reducing the harmful environmental impact of waste electrical equipment by restricting the use of known dangerous substances. Based on information received from our supply sources, LasersCom LLC hereby states that the banned substances listed in the RoHS directive are not found in the parts and materials used above the threshold level listed other than exceptions approved by the European Commission.

## **REACH Compliance Statement**

Registration, Evaluation, Authorisation and Restriction of Chemicals (REACH) is a European Union regulation 1907/2006/EC that addresses the production and use of chemical substances, and their potential impacts on human health and the environment. Based on information received from our supply sources, LasersCom LLC hereby states compliance of the parts and materials used in manufacturing to REACH regulation. LasersCom LLC does not manufacture or import any substances or preparations as defined under REACH.