

# LDS-905-FP-100

## OVERVIEW

LDS-905-FP-100 is the laser diode coupled to an optical fiber and packaged into a hermetic case

## MAIN FEATURES

- Wavelength: 905 nm
- Cavity type: Fabry-Perot
- Optical power: up to 100 mW in CW mode in single-mode fiber Nufern 780-HP
- Package types: coaxial with bracket, 14 pin DIL
- Built-in monitor photodiode

## APPLICATIONS

- Laser systems

## ORDERING INFORMATION

# LDS-905-FP-100-X-3-X-X-X-X

### Case type

**B:** compact coaxial with double-sided bracket  
**T:** 14 pins DIL with thermal stabilization (TEC and thermistor)  
**E:** 14 pins DIL with thermal stabilization (TEC and thermistor)  
 Other type on request

### Fiber type

**SM05:** SM, [Corning HI 780](#), furcation tubing  $\varnothing 0.9$  mm  
**SMP05:** PM, [Fujikura SM85](#), PANDA type, furcation tubing  $\varnothing 0.9$  mm  
**SM1:** G.657.A1, [Corning SMF-28 Ultra](#), furcation tubing  $\varnothing 0.9$  mm  
**SM3:** G.657.B3, [Corning ClearCurve ZBL](#), furcation tubing  $\varnothing 0.9$  mm  
**MM5:** MM, [50/125\\_OM2](#), furcation tubing  $\varnothing 0.9$  mm  
**MM6:** MM, [62.5/125\\_OM1](#), furcation tubing  $\varnothing 0.9$  mm  
 Other type on request

### Connector type

**FU:** FC/UPC (SM05, SMP05, SM1, SM3, MM5, MM6)  
**FA:** FC/APC (SM05, SMP05, SM1, SM3)  
**N:** no connector  
 Other type: on request

### Test measurements

**CW:** CW mode (electro-optical parameters at  $T=25\pm 5$  C and spectrum)

### Fiber length

**0.5:** 500 $\pm$ 50 mm  
**1.0:** 1000 $\pm$ 100 mm  
 Other length on request

# LDS-905-FP-100

## ABSOLUTE MAXIMUM RATINGS

Parameter		Value	Unit	Conditions
Laser diode forward current*	$I_{max}$	255	mA	CW, $T = 25^{\circ}\text{C}$
Laser diode reverse voltage	$V_{RL}$	2	V	
Photodiode reverse voltage	$V_{RP}$	30	V	
Operating temperature**	$T_{OP}$	-10 - +60	$^{\circ}\text{C}$	Package B
Operating temperature**	$T_{OP}$	-40 - +60	$^{\circ}\text{C}$	Package T, E ( $T_{st} = 25^{\circ}\text{C}$ )
Storage temperature	$T_{stg}$	-40 - +85	$^{\circ}\text{C}$	
Soldering temperature	$T_{sold}$	260	$^{\circ}\text{C}$	Max. 5 seconds

\*Maximal laser diode forward current depends on the operating temperature. Please, refer to the figure below.

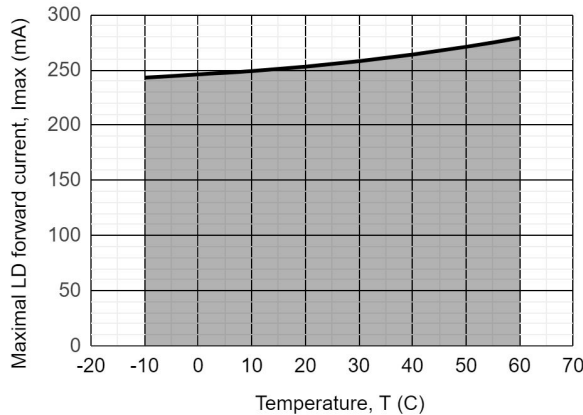

\*\*Operating temperature is defined by the case temperature. It is recommended to ensure sufficient heat dissipation so that the module's maximum operating temperature is not exceeded.

Operating temperature for the DIL-14-pins case (T or E) with TEC is defined for internal temperature stabilization at  $T_{st} = 25^{\circ}\text{C}$  that corresponds to thermistor resistance  $R_t = 10\text{ k}\Omega$ .

# LDS-905-FP-100

## ELECTRICAL-OPTICAL CHARACTERISTICS (T = 25 °C)

Parameter		MIN	TYP	MAX	Unit	Conditions
Optical power (CW)	P <sub>cw</sub>	100			mW	CW, I <sub>op</sub> = 250 mA, SM05
Mean wavelength	λ	895	905	915	nm	CW, I <sub>op</sub> = 250 mA
Spectral width	Δλ		2	4	nm	CW, I <sub>op</sub> = 250 mA
Wavelength-temperature coefficient	dλ/dT		0.31		nm/°C	CW, I <sub>op</sub> = 250 mA
Threshold current	I <sub>th</sub>		25	60	mA	
Slope efficiency	S <sub>e</sub>	0.40	0.45		mW/mA	CW, SM05
Operating voltage	V <sub>op</sub>		2.2	2.5	V	CW, I <sub>op</sub> = 250 mA
Monitor current	I <sub>m</sub>	0.1	0.5	1.0	mA	CW, I <sub>op</sub> = 250 mA, V <sub>r</sub> = 5 V
Polarization extinction ratio	PER	17			dB	CW, SMP05
Front-to-rear tracking error	E <sub>r</sub>		0.5	1.0	dB	CW, P <sub>cw</sub> = 3 mW, SM05, T = -10 ~ +50°C

Tracking error E<sub>r</sub> = max |10 lg [P(T)/P(25°C)]|, I<sub>m</sub> = const, T = T<sub>min</sub> ~ T<sub>max</sub>  
 Pulse mode: pulse width 10 μs, duty cycle = 1%

# LDS-905-FP-100

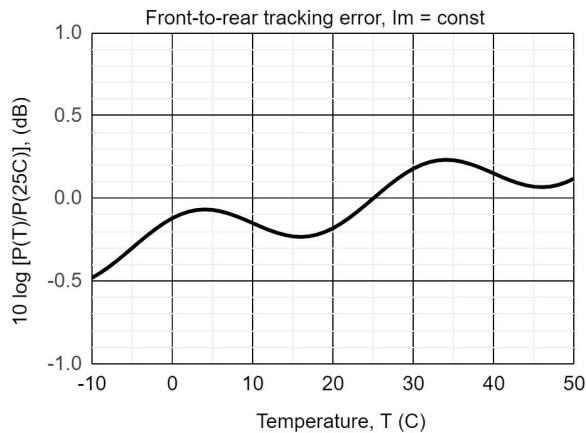
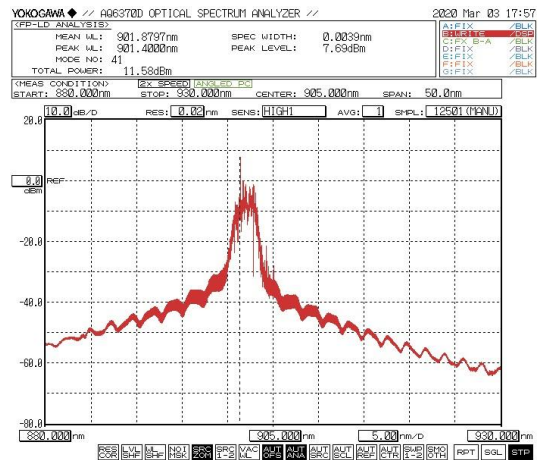
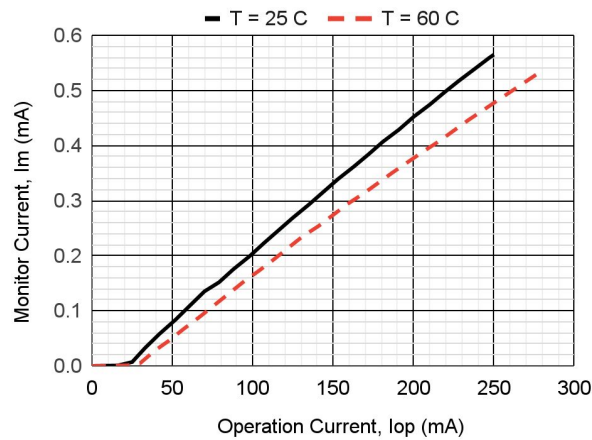
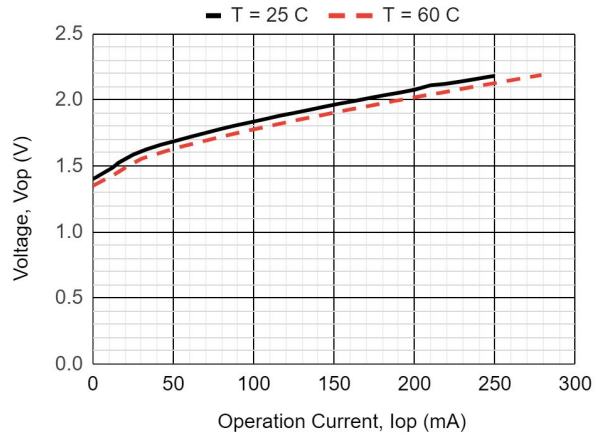
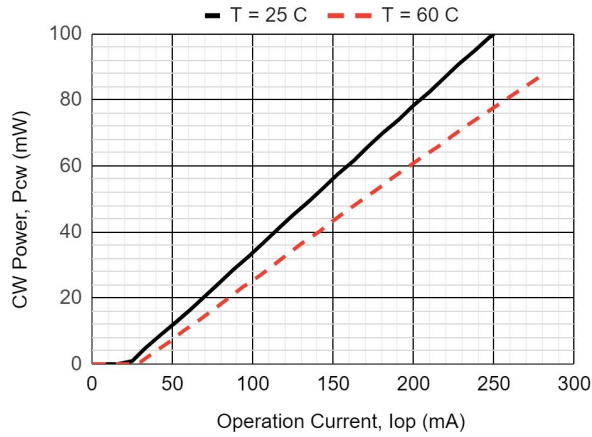

# LDS-905-FP-100

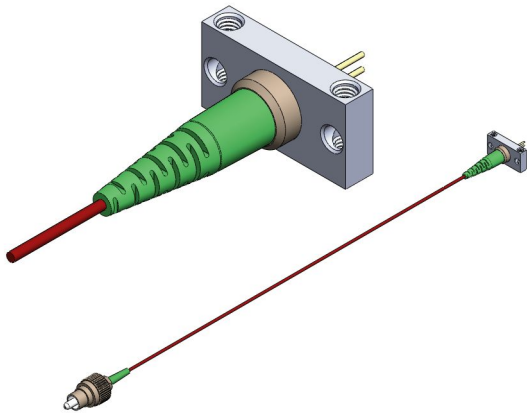

## PACKAGE B

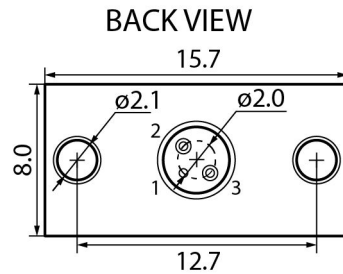

PINOUT #3

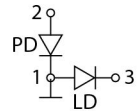

Download more information



## PACKAGE T

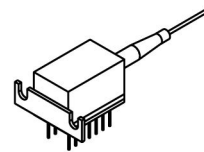
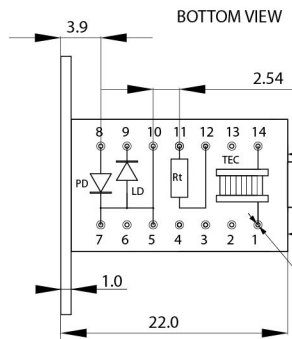
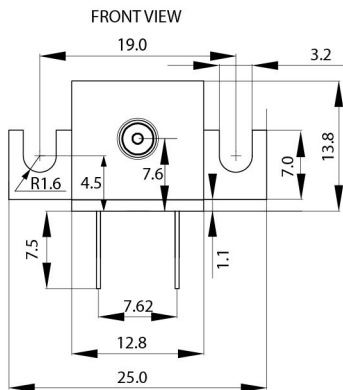

PINOUT #2, #3

- 1.TEC Anode
- 2.-
- 3.-
- 4.-
- 5.LD Anode
- 6.-
- 7.PD Cathode, LD Anode
- 8.PD Anode
- 9.LD Cathode
- 10.LD Anode
- 11.Thermistor
- 12.Thermistor
- 13.-
- 14.TEC Cathode

TEC:  $I_{max} = 1.4A$ ,  $U_{max} = 3.9V$ ,  $Q_{max} = 3.3W$ ,  
AC R = 2.0 Ohm,  $\Delta T_{max} = 69K$

Thermistor:  
 $R_t = 10 * \text{EXP}(3600 * (1/T[K] - 1/298))$  kOhm

Download more information



## PACKAGE E

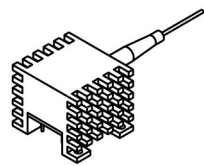
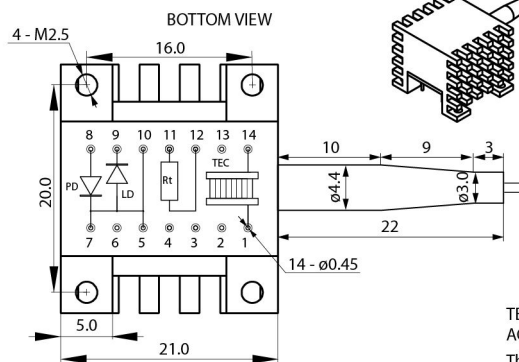
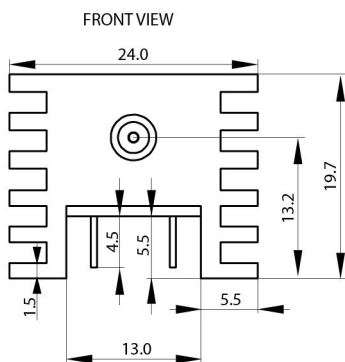

PINOUT #2, #3

- 1.TEC Anode
- 2.-
- 3.-
- 4.-
- 5.LD Anode
- 6.-
- 7.PD Cathode, LD Anode
- 8.PD Anode
- 9.LD Cathode
- 10.LD Anode
- 11.Thermistor
- 12.Thermistor
- 13.-
- 14.TEC Cathode

TEC:  $I_{max} = 1.4A$ ,  $U_{max} = 3.9V$ ,  $Q_{max} = 3.3W$ ,  
AC R = 2.0 Ohm,  $\Delta T_{max} = 69K$

Thermistor:  
 $R_t = 10 * \text{EXP}(3600 * (1/T[K] - 1/298))$  kOhm

Download more information



# LDS-905-FP-100

---

Characteristics, data, materials and structures specified in this datasheet are subject to change without notice. Please refer to the latest specification before use of the products.

## **Safety and handling cautions**

1. Avoid smashing and burning of the module. Avoid storing and using the module in conditions where water, organic solvents or aggressive acids or bases may contact the module or where there is a possibility of exposure to corrosive gases, explosive gases, dust, salinity or other harsh conditions. The module should be disposed as special industrial waste.
2. Exceeding absolute maximum ratings even for a short time can cause permanent damage of the module.
3. The module is sensitive to and can be broken by ESD (static electricity).

## **Conflict Minerals Policy Statement**

LasersCom LLC achieves business objectives and customer needs with social responsibility. We do not support or contribute to the violence and human rights violations associated with the mining of conflict minerals coming from Conflict Regions according to US "Dodd-Frank Act". When possible, our suppliers' conflict mineral statements are reviewed. We do not directly purchase Conflict Minerals from any source and do not knowingly procure any parts and products containing Conflict Minerals from Conflict Regions.

## **RoHS Compliance Statement**

Restriction of Hazardous Substances (RoHS) directive (Directive 2011/65/EC amended with Directive (EU) 2015/863) is the directive aimed at reducing the harmful environmental impact of waste electrical equipment by restricting the use of known dangerous substances. Based on information received from our supply sources, LasersCom LLC hereby states that the banned substances listed in the RoHS directive are not found in the parts and materials used above the threshold level listed other than exceptions approved by the European Commission.

## **REACH Compliance Statement**

Registration, Evaluation, Authorisation and Restriction of Chemicals (REACH) is a European Union regulation 1907/2006/EC that addresses the production and use of chemical substances, and their potential impacts on human health and the environment. Based on information received from our supply sources, LasersCom LLC hereby states compliance of the parts and materials used in manufacturing to REACH regulation. LasersCom LLC does not manufacture or import any substances or preparations as defined under REACH.