

PDI-200-Si-P20-2G-K

Preliminary

OVERVIEW

PDI-200-Si-P20-2G-K is the Si PIN photodiode coupled to an optical fiber and packaged into a hermetic case

MAIN FEATURES

- Spectral range: 400-1000 nm
- Maximum optical input power: 20 mW
- Typical peak responsivity: 0.35-0.40 A/W at wavelength 850 nm
- Package type: coaxial, coaxial with bracket
- Low back reflection

APPLICATIONS

- Optical fiber communication systems
- Spectroscopy

ORDERING INFORMATION

PI-200-Si-P20-2G-K - X - X - 7 - X - X - X

Optical matching

R40: back reflection < -40 dB (SM03, SM04, SM05, SM06, SM1 and SM3 fiber)

R30: back reflection < -30 dB (MM5 and MM6 fiber)

RM: back reflection -30 dB, optical matching, +5% higher responsivity

Case type

U: compact coaxial

B: compact coaxial with double-sided bracket

Fiber type

SM03: Nufern S405-XP, furcation tubing Ø0.9 mm

SM04: Nufern 630-HP, furcation tubing Ø0.9 mm

SM05: Nufern 780-HP, furcation tubing Ø0.9 mm

SM06: Corning HI-1060, furcation tubing Ø0.9 mm

SM1: G.657.A1, furcation tubing Ø0.9 mm

SM3: G.657.B3, furcation tubing Ø0.9 mm

MM5: 50/125, furcation tubing Ø0.9 mm

MM6: 62.5/125, OM2, furcation tubing Ø0.9 mm

Other type: on request

Connector type

FU: FC/UPC

FA: FC/APC

N: no connector

Other type: on request

Fiber length

0.5: 500+/-50 mm

1.0: 1000+/-100 mm

Other length: on request

PDI-200-Si-P20-2G-K

ABSOLUTE MAXIMUM RATINGS

Parameter		Value	Unit	Conditions
Maximum optical input power	P_{\max}	20	mW	
Reverse voltage	V_R	50	V	
Reverse current	I_R	10	mA	
Forward current	I_F	1	mA	
Operating temperature	T_{op}	-40 ÷ +85	°C	
Storage temperature	T_{stg}	-40 ÷ +85	°C	
Soldering temperature	T_{sold}	260	°C	Max. 5 seconds

ELECTRICAL-OPTICAL CHARACTERISTICS (T = 25 °C)

Parameter		Min	Typ	Max	Unit	Conditions
Operating wavelength	λ	400		1000	nm	
Responsivity	R		0.35		A/W	$V_R = 3 \text{ V}$, $\lambda = 850 \text{ nm}$
Dark current	I_d		10	40	pA	$V_R = 3 \text{ V}$
Total capacitance	C_t		1.2	1.6	pF	$V_R = 2.5 \text{ V}$, $f = 1 \text{ MHz}$
Cutoff frequency	f_c		2.0		GHz	$V_R = 2.5 \text{ V}$, $R_L = 50 \Omega$

PDI-200-Si-P20-2G-K

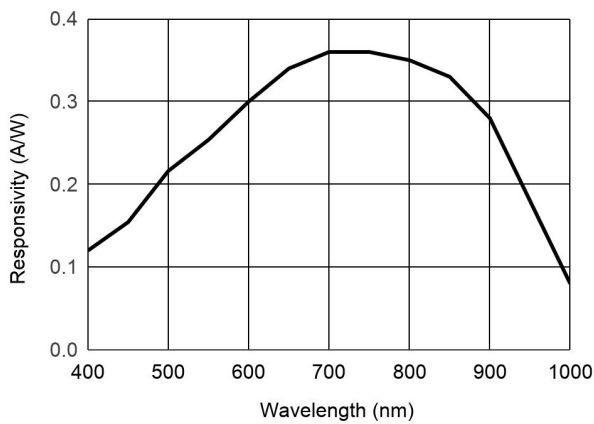
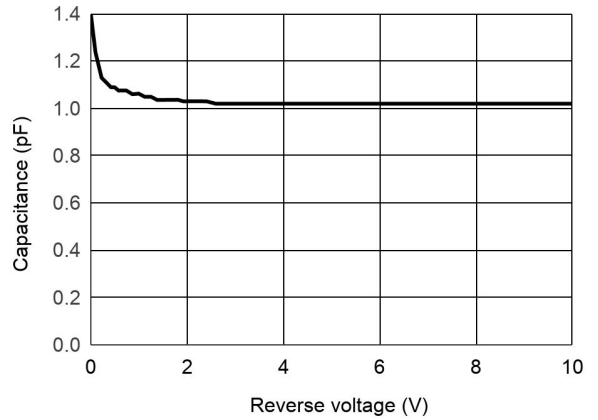
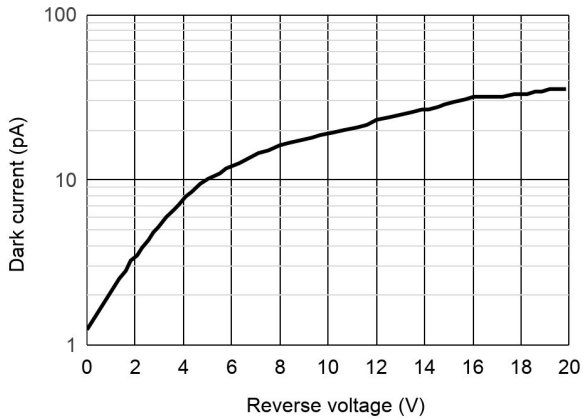

PDI-200-Si-P20-2G-K

PACKAGE TYPE AND ELECTRICAL PINOUT

PACKAGE U

SIDE VIEW

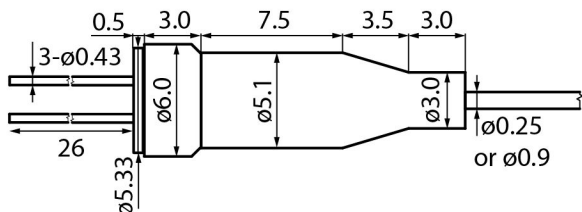

BACK VIEW

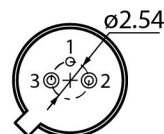

PINOUT
#7

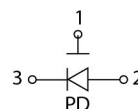

Connector FC/UPC, FC/APC, no connector, or by request

Fiber length 500+/-50, 1000+/-100, or by request

PACKAGE B

SIDE VIEW

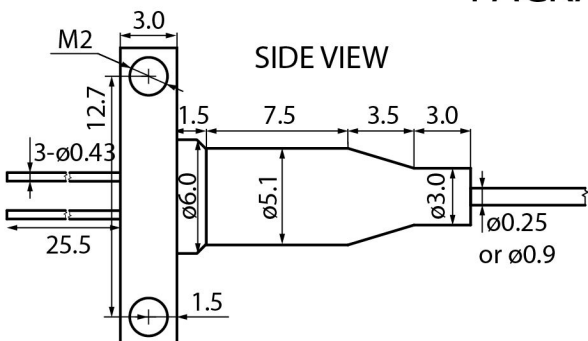

BACK VIEW

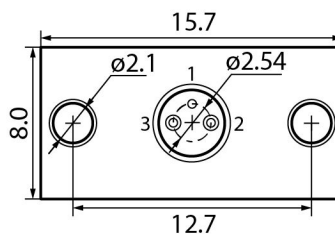

PINOUT
#7

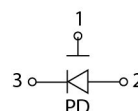

Connector FC/UPC, FC/APC, no connector, or by request

Fiber length 500+/-50, 1000+/-100, or by request

PDI-200-Si-P20-2G-K

Characteristics, data, materials and structures specified in this datasheet are subject to change without notice. Please refer to the latest specification before use of the products.

Safety and handling cautions

1. Avoid smashing and burning of the module. Avoid storing and using the module in conditions where water, organic solvents or aggressive acids or bases may contact the module or where there is a possibility of exposure to corrosive gases, explosive gases, dust, salinity or other harsh conditions. The module should be disposed as special industrial waste.
2. Exceeding absolute maximal ratings even for a short time can cause permanent damage of the module.
3. The module is sensitive to and can be broken by ESD (static electricity).

Conflict Minerals Policy Statement

LasersCom LLC achieves business objectives and customer needs with social responsibility. We do not support or contribute to the violence and human rights violations associated with the mining of conflict minerals coming from Conflict Regions according to US "Dodd-Frank Act". When possible, our suppliers' conflict mineral statements are reviewed. We do not directly purchase Conflict Minerals from any source and do not knowingly procure any parts and products containing Conflict Minerals from Conflict Regions.

RoHS Compliance Statement

Restriction of Hazardous Substances (RoHS) directive (Directive 2011/65/EC amended with Directive (EU) 2015/863) is the directive aimed at reducing the harmful environmental impact of waste electrical equipment by restricting the use of known dangerous substances. Based on information received from our supply sources, LasersCom LLC hereby states that the banned substances listed in the RoHS directive are not found in the parts and materials used above the threshold level listed other than exceptions approved by the European Commission.

REACH Compliance Statement

Registration, Evaluation, Authorisation and Restriction of Chemicals (REACH) is a European Union regulation 1907/2006/EC that addresses the production and use of chemical substances, and their potential impacts on human health and the environment. Based on information received from our supply sources, LasersCom LLC hereby states compliance of the parts and materials used in manufacturing to REACH regulation. LasersCom LLC does not manufacture or import any substances or preparations as defined under REACH.